

Solutions for Fluid Technology



OPERATING INSTRUCTIONS

"pulse-generator TB2" Testbox
Generator for generating A and B quadrature signals

CONTENTS

	Page
Important information and legal notices	3
1. General Information	4
2. Description	4
3. The "manual" Operating Mode	5
3.1. Description of the "manual" operating mode	5
3.2. Using the "manual" mode of operation	6
4. The "VS(I)" and "RS(HT)" Mode of Operation	7
4.1. Description of the "VS(I)" mode of operation	7
4.2. Description of the "RS(HT)" mode of operation	7
4.3. Operating the "VS(I)" and "RS(HT)" mode of operation	8
5. The "IMPULS" Mode of Operation	10
5.1. Description of the "IMPULS" mode of operation	10
5.2. Functions of the "IMPULS" mode of operation	10
6. The "sweep" Mode of Operation	10
6.1. Description of the "sweep" mode of operation	10
6.2. Functions of the "sweep" mode of operation	11
6.3. Operating the "sweep" mode of operation	12
7. Resetting to the Works Setting	15
8. "pulse - generator TB2" Testbox Connections	15
9. Technical Data	17

The current publication of this operating instruction supersedes all information from previous publications. VSE reserves the right to make changes and substitutions. VSE is not liable for any printing errors. Reproduction, including excerpts, is permitted only after written approval by VSE. VSE reserves the right to modify technical data at any time. Last revised: 08/2018



IMPORTANT INFORMATION AND LEGAL NOTICES

Dear customer, dear user,

This operating instruction for the "testbox pulse generator TB2" by VSE Volumentchnik GmbH (VSE) contains information required to properly install and commission the pulse generator for the intended purpose.

Any installation, commissioning, operation, maintenance and testing may only be carried out by trained and authorized personnel. The operating instructions must be read and followed carefully to ensure a trouble-free, proper and safe operation of the pulse generator. In particular, the safety instructions are essential.

These operating instructions must be kept safe and accessible for the authorized personnel at all times. At no time should contents of the operating instructions be removed. A missing manual or missing pages must be replaced immediately if lost. The operating instructions can be requested at any time from VSE or downloaded from our website www.vse-flow.com. The operating instructions must be passed on to each subsequent user of the pulse generator.

This operating instruction is not subject to any modification service by VSE. VSE reserves the right to make technical changes at any time without notice.

VSE makes no warranties, express or implied, with respect to commercial qualities and suitability for a particular purpose.

VSE accepts no liability for damage and malfunctions resulting from operating errors, failure to observe these operating instructions, improper installation, commissioning or maintenance as well as improper use of the pulse generator.

The opening of the pulse generator is absolutely not permitted. After an unauthorized opening or rebuilding as well as after a single, incorrect connection of the flow circuits of the pulse generator the warranty as well as the product liability by VSE expire.

1. GENERAL INFORMATION

- Simulates the output signals of incremental measuring systems (A,B with 90° phase shifting)
- Output frequency adjustable between 0 and 250 kHz
- Resolution of 0.1 Hz
- Frequency accuracy of 100ppm
- Simulation of flow metering with VSE VS(I) series and RS(HT) series flow meters
- Sweep function which takes the direction of rotations of the most diverse frequency ranges into account
- Impulse – Generator
- Reversible direction of rotation (phase position A/B)
- Adjustable frequency/flow divisions during operation
- Output A, B with HTL level 10 – 28 V; optional additional differential outputs A,/A; B,/B with HTL level 10 – 28V or RS422 level
- Large distribution voltage range 10 – 28V DC

It is not possible to imagine not using incremental measuring systems in almost all industrial areas. This technology is wide-spread for flow metering in fluid engineering and rotational speed counting in motion power engineering alone. Additional applications are path measuring, position measuring and speed measuring in industrial system solutions.

With the „pulse – generator TB2“ testbox from VSE Volumentchnik GmbH, incremental sensor signals or two 90° phase-shifted pulse signals A and B are generated respectively. This pulse generator is able to generate frequencies of between 0.1 Hz and 250,000.0 Hz. The resolution is 0.1Hz. The incremental rotary encoder signals can either be adjusted by directly entering the frequency or by using a special menu to specify flow meter values from the VS(I) series and RS(HT) series of VSE flow meters. The construction size, interpolation factor and the corresponding flow unit are taken into account when generating the flows. An additional menu can be used to run through stipulated frequency ranges. Hereby, the direction of rotation is switched, depending on the set frequency range, i.e. the phase position of both of the quadrature signals A and B is shifted by 90° null.

It is a very useful and inexpensive means for the simulation of incremental encoder signals.

2. DESCRIPTION

The „pulse – generator TB2“ testbox has three different types of operation or modes:

1. „manual“ mode: setting of a frequency of between 0.1Hz and 250,000.0Hz
2. „VS(I)“ mode: setting of a measured flow value, stipulating the VS(I) constructional size, the interpolation factor and the flow unit
3. „RS(HT)“ mode: setting of a measured flow value, stipulating the RS(HT) constructional size, the interpolation factor and the flow unit

The following tasks can be fulfilled with the assistance of the incremental pulse encoder:

- Qualifying of the possibilities of use of a measuring system for the desired application
- Checking of the layout of an incremental measuring system
- Testing the functional testing of machine components and control units or evaluation units during the development phase
- Checking of the setting parameters of electronic evaluation units or converters without installing the mechanical components (e.g. flow sensors)
- Checking of the cabling between the sensory technology and the electronic measuring devices during commissioning
- Simulation of incremental sensor signals when servicing plants
- Simulation of the flow quantities of VSE flow meters (VS(I) series)
- Checking of incremental measurement data recordings and their dynamics
- Testing the frequency behavior of switchings
- Simple error analysis in case of plant disturbances
- Volume measurement for testing dosing applications

4. „impulse“ mode: Output of specific pulse count with a predefined frequency
5. „sweep“ mode: setting of linear sweep ranges between two frequency values

The operation of the „pulse – generator TB2“ testbox is quickly understood and utilizes the simple keypad.

3. THE „MANUAL“ OPERATING MODE

3.1. Description of the “manual” operating mode

The “manual” operating mode enables a direct entering of the user-related frequency. The desired frequency can simply be entered using the numeric keypad. The entered frequency will be stored after it has been acknowledged. The output of the incremental pulses is started and stopped using the separate start/stop key [ON]. The direction of rotations can be changed, i.e. the phase position of both of the quadrature signals can be shifted by 90° (see Fig. 1) using the “direction” [↔] key. An additional function is pro-

vided by the [%] key, with which the entered frequency can be directly split. If only this key is activated, the frequency is output in the following percentages: 10%, 1%, 100%. In combination with a numeric key, it is possible to enter the frequency in percentages of 10, e.g. pressing the keys [%] and [6] simultaneously results in 60% of the entered frequency being output. The frequency display is updated accordingly.

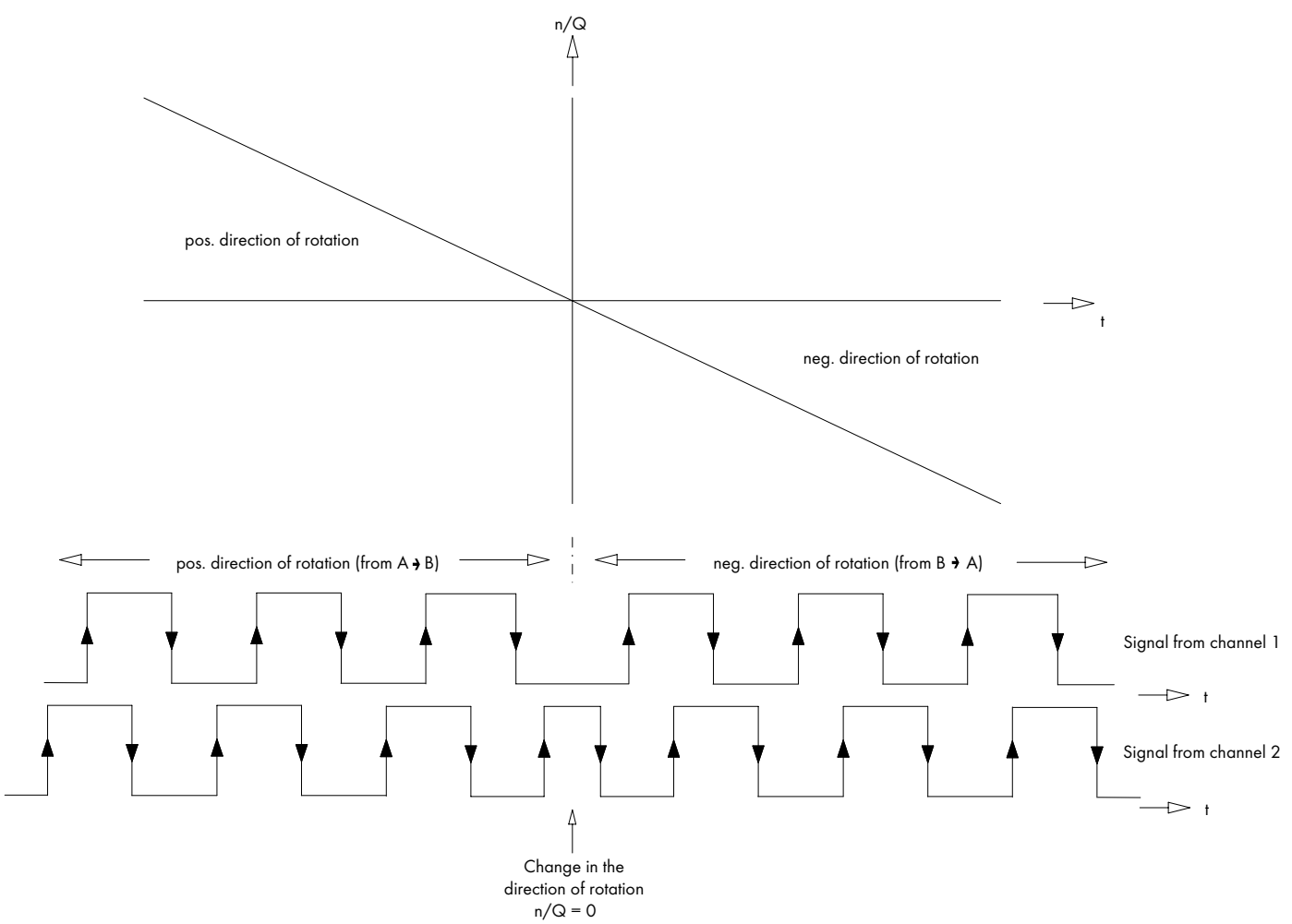

Fig. 1: Change of direction of the quadrature signals

3.2. Using the „manual“ mode of operation

The „manual“ mode of operation is used as follows:

General operation of the "manual" mode of operation



Change between each of the menu items



Entering the selected menu item



direction

Changing the direction of rotation



start / stop

Enable / Disable of frequency-output

Mode MANUAL [Start]

- 100% Frequency

≥FRQ +0001201 Hz

>change Mode VS(!)

Mode of operating display; Status of the frequency output

Displays the current frequency output split

Frequency entry menu item

Mode of operation selection menu item



split

Splitting the frequency output 10%, 1%, 100%



split

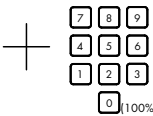

Splitting the frequency output 10%, 20%, 30%, 40%, 50%, 60%, 70%, 80%, 90%, 100%

Operation of the "frequency entry" menu item

Mode MANUAL [Start]

- 100% Frequency

xFRQ +000120.1 Hz

>change Mode VS(!)

Frequency entry menu item



Changing the cursor position



Changing the direction of rotation in the entry

direction



Increase the selected number (+1)



Decrease the selected number (-1)



Direct entry of the numbers



Confirmation of the entered frequency value
Return to the menu item selection

Operation of the "mode of operation selection" menu item

Mode MANUAL [Start]

- 100% Frequency

>FRQ +0001201 Hz

xchange Mode VS(!)

Mode of operation selection menu item



Selection of the mode of operation



Confirmation of the selected mode of operation
Entering the selected mode of operation
or return to the menu item selection

4. THE „VS(I)“ AND „RS(HT) „ MODE OF OPERATION

4.1. Description of the “VS(I)” mode of operation

The “VS(I)” (VS(I)flow meter series) mode of operation was especially developed for the “VS(I)” and flow sensor system from VSE Volumentechnik.

Flow meters made by VSE Volumentechnik GmbH measure the volume flow of liquids according to the toothed wheel principle. A pair of very precisely adjusted toothed wheels in the housing constitutes the meter. A signal pick-up system registers the meter rotation free of contact and tooth by tooth. Each tooth is output as a digital pulse. The gaps in the teeth of the meter wheels form meter chambers in the areas in which they are completely enclosed by the housing walls; these chambers digitalize liquid flow depending on their chamber volume. The liquid flow quantity within one meter rotation of a tooth division forms the volume measurement per pulse (V_m) and is defined in cm^3/pulse . It identifies the constructional size of a flow meter. The two-channel, incremental output of the digital signals provides a higher measured value resolution and a detection of the flow direction.

4.2. Description of the “RS(HT)” mode of operation

RS flow meters measure the flow rate based on the screw pump principle. A pair of rotors fitted precisely into the housing constitutes the measuring element. An integrated gear and non-contact signal pick-up system detects the rotations of the measuring element and converts them to digital pulses. Together with the housing walls, the rotor edges form closed measuring chambers in which the fluid is transported from the inlet to the outlet side. The fluid volume put through within one main rotor rotation is the rotation volume, which is divided by the sensing gear and digitized, processed and output in the sensor module.



Fig. 2: VSE flow meters

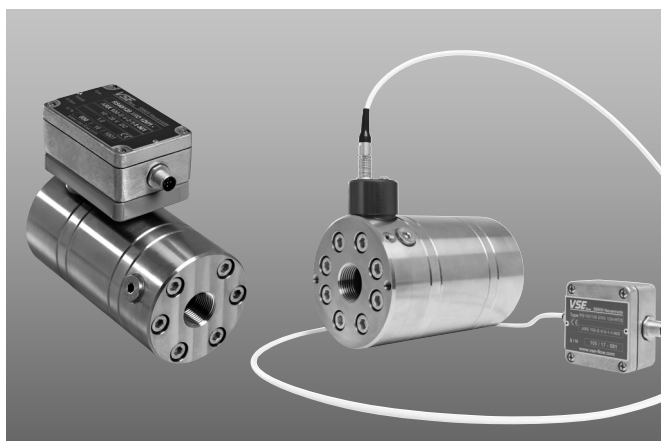





Fig. 3: RS-Standard and RS High Temperature flow meters

An explicit simulation of the flow values of these flow meters is possible in the “VS(I)” and “RS(HT)” mode of operation.

The constructional sizes of the VS(I) and RS(HT) are included in a menu item in a selectable tabular form. The corresponding interpolation factor can also be selected, when using VSI/RS(HT) flow meters. This is to be programmed with 1, when using the standard VS version. The desired flow is directly entered using the numeric keys. A corresponding flow unit is to be set prior to this. A choice can be made from seven different units:

The flow entry field is adapted in accordance with the selected construction size and unit.

The unit can also be changed during operation by using the “unit”  key. The flow meter value display is changed automatically.

If the unit “Hz” should be selected, the corresponding output frequency is displayed, taking the set frequency split parameter and the IPF factor into account. Furthermore, in this mode it is also possible to have the flow meter value or frequency respectively, displayed as a percentage of the entry, by using the “split”  key or a corresponding key combination (e.g.  and ).

Unit	Display
Liters per minute (l/min)	l/min
Liters per hour (l/h)	l/h
Liters per second (l/s)	l/s
US gallons per minute (USgal/min)	GPM
US gallons per hour (USgal/h)	GPH
US gallons per second (USgal/s)	GPS
Frequency display (Hz)	Hz

Table 1: programmable units

With these options, one is explicitly able to simulate flows in order to set and optimize the evaluation and converter units correspondingly without taking the fluid circulation into operation or having to make an installation.

The construction size VS(I)/RS(HT), interpolation factor IPF, flow meter value Q and the flow unit are stored after they have been entered in the device.

4.3. Operating the "VS(I)" and "RS(HT)" mode of operation

You will find a detailed description of the usage of the "VS(I)" and "RS(HT)" menu on the following pages.

General operation of the "VS(I)" and "RS(HT)" mode of operation



Mode of operation display; Status of the flow output



Change between each of the menu items

VS(I)/RS(HT) size menu / interpolation factor IPF menu



Current flow output split display



Entering the selected menu item

Flow entry menu item

Mode of operation selection menu item



direction

Changing the flow direction



start / stop

Enable / Disable the flow output



unit

Direct changing of the unit



split

Splitting the flow output 10%, 1%, 100%



split

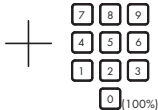

Splitting the flow output 10%, 20%, 30%, 40%, 50%, 60%, 70%, 80%, 90%, 100%

Mode VS(I) [Stop]

>VS(I) 0.02 >IPF 10

- 90% Flow

≥Q-00001.25 l/min

>change Mode RS(HT)

Mode RS(HT) [Stop]

>RS 400 >IPF 10

- 90% Flow

≥Q-00001.25 l/min

>change Mode IMPULS

Mode RS(HT) [Stop]

>RS(HT) 400 >IPF 10

- 90% Flow

≥Q-00001.25 l/min

>change Mode IMPULS

Operation of the "RS(HT) size" menu item

Mode RS(HT) [Stop]

xRS 40 >IPF 10

- 90% Flow

>Q-00001.25 l/min

>change Mode IMPULS

RS(HT) size menu item



Selection of the size (40; 100; 400; 800; 2.500 HT 40; HT 100; HT 400; HT 800; HT 2500)



Confirmation of the selected RS(HT) size
Return to the menu item selection



Operation of the "interpolation factor IPF" menu item

Mode RS(HT) [Stop]

>RS 40 xIPF 10

- 90% Flow

>Q-00001.25 l/min

>change Mode IMPULS

Interpolation factor IPF menu item



Selection of the IPF (1, 2, 5, 10, 25, 32, 50, 64, 100, 128)



Confirmation of the selected interpolation factor IPF
Return to the menu item selection



Operation of the "VS(I) size" menu item

```

Mode VS(I) [Stop]
xVS(I) 0.02 >IPF 10
- 90% Flow
>Q-00001.25 l/min
-----
>change Mode RS(HT)

```

- VS(I) size menu item
- Selection of the size (0,02; 0,04; 0,1; 0,2; 0,4; 1; 2; 4; 10)
 -
 - Confirmation of the selected VS(I) size
Return to the menu item selection

Operation of the "interpolation factor IPF" menu item

```

Mode VS(I) [Stop]
>VS(I) 0.02 xIPF 10
- 90% Flow
>Q-00001.25 l/min
-----
>change Mode RS(HT)

```

- Interpolation factor IPF menu item
- Selection of the IPF (1, 2, 3, 4, 5, 8, 10, 12, 16)
 -
 - Confirmation of the selected interpolation factor IPF
Return to the menu item selection

Operation of the "flow value entry" menu item

```

Mode VS(I) [Stop]
>VS(I) 0.02 >IPF 10
- 90% Flow
xQ-00001.25 l/min
-----
>change Mode RS(HT)

```

- Flow value entry menu item
- Changing the cursor position
 - or Changing the direction of rotation in the entry
direction
 - Increase the selected number (+1)
 - Decrease the selected number (-1)
 - Selecting the flow unit
 -
 - Direct entering of the numbers
 -
 -
 - Confirmation of the entered frequency value
Return to the menu item selection

Operation of the "mode of operation selection" menu item

```

ModeVS( I) [Stop]
>VS( I) 0.02 >IPF 10
- 90% Flow
>Q-00001.25 l/min
-----
xchangeMode RS(HT)

```

- Mode of operation selection menu item
- Selection of the mode of operation
 -
 - Confirmation of the selected mode of operation
Entering the selected mode of operation menu or return to the menu item selection

5. THE "IMPULS" MODE OF OPERATION

5.1. Description of the "IMPULS" mode of operation

The "IMPULS" mode enables the user to output a certain number of impulses with a predefined frequency in order to simulate volume measurements. The output volume can be calculated with the following equations:

$$\text{impulse count} = \text{output volume [l]} \times K_{\text{factor}} [\text{Imp/l}] \quad \text{Equation 5.0}$$

$$f [\text{Hz}] = \frac{Q [\text{l/min}] \times K_{\text{factor}} [\text{Imp/l}]}{60} \quad \text{Equation 5.1}$$

To output pulses in the negative direction, the frequency can be inverted with the \pm key.

5.2. Functions of the "IMPULS" mode of operation

The menu "IMPULSE" is served as follows:

1. Input of the impulse count (from Equation 5. 0) in the field "No. Imp."
2. Input of the output frequency in Hz (from the Equation 5. 1) in the field "FRQ"
3. Start the impulse output with the "start/stop" key.

During the impulse output the process can be stopped with the "start/stop" key. By doing so, the counter is reset, i. e. it cannot be paused.

The impulse output is finished, when the status indicator changes back to "START".

General operation of the "IMPULS" mode of operation



Mode of operation display; Status of the flow output



Change between each of the menu items

IMPULS menu / impulse count



Display of the output frequency



Entering the selected menu item

Mode of operation selection menu item



Changing the flow direction

direction



Enable / Disable the flow output

start / stop

Mode IMPULS [START]

>No. Imp 001000

>FRQ +001000.0 Hz

≥change Mode MANUAL

6. THE "SWEEP" MODE OF OPERATION

6.1. Description of the "sweep" mode of operation

The "sweep" operation enables the scan or sweep of a fixed range between two frequency values.

The start frequency, end frequency and the sweep time are programmed. Different frequency directions can also be selected. One function permits the starting of the sweep process with null or in a null scan respectively. This enables the simulation of the most diverse incremental frequency processes such as a flow characteristic for a servo valve.

The sweep characteristic is linear (ramp). It should, however, be taken into account that the frequency is actually changed incrementally and not linear. It should also be taken into account how the device actually reacts if extreme sweep time and sweep range combinations are used. In sweep mode, the software generates a table with 1200 intermediate frequencies, including the stipulated start and end frequencies. In the activated sweep mode, each of the used frequencies has to be extracted from the table and processed.

The frequency resolution of the steps depends on the programmed sweep range and the sweep time or sweep rate respectively.

A wide sweep range and a fast sweep rate result in a very rough frequency resolution of the steps.

Generally speaking, "sweeping" is normally used in connection with a measuring data recording or with an oscilloscope, in order to test the frequency behavior of evaluation devices or circuits.

A separate trigger outlet "TRIGOUT" is available for the triggering of oscilloscopes. This trigger outlet goes to low level at the start of the sweep and remains in this status during the first frequency step. The TRIGOUT status returns to high level after the first frequency step has been completed.

The "sweep" mode of operation has the following technical data:

- Sweep simulations of incremental frequency responses with and without changes of direction
- Sweep modes of operation: single sweep and continuous sweep operation due to adjustable loops
- Sweep characteristic: linear
- 4 different incremental sweep modes with two cutoff frequencies can be programmed
- The start and end frequencies can be adjusted infinitely (0.1...250,000.0Hz) within a range
- Triggering of an oscilloscope or x-y recorder possible due to an additional trigger outlet TRIGOUT
- Sweep direction exchangeable via a mode change-over
- "Sweep-Start" can be adjusted at zero or at "start on zero"
- Sweep time can be infinitely variably adjusted between 0.1s ... 20.0s
- A programmable number of loops can be adjusted between 1 and 1000

6.2. Functions of the "sweep" mode of operation

The following "sweep" functions of incremental signals are possible with the "pulse - generator TB2":

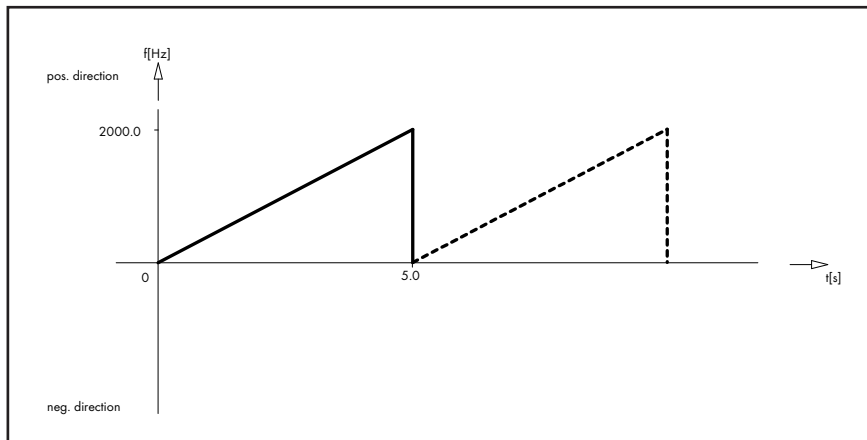

Example 1

Settings:

- Sweep UP (FRQ_1 ==> FRQ_2)
- FRQ_1 +000000.0Hz
- FRQ_2 +002000.0Hz
- Start on zero off
- SweepTime 005.0s
- No. of loops 0002

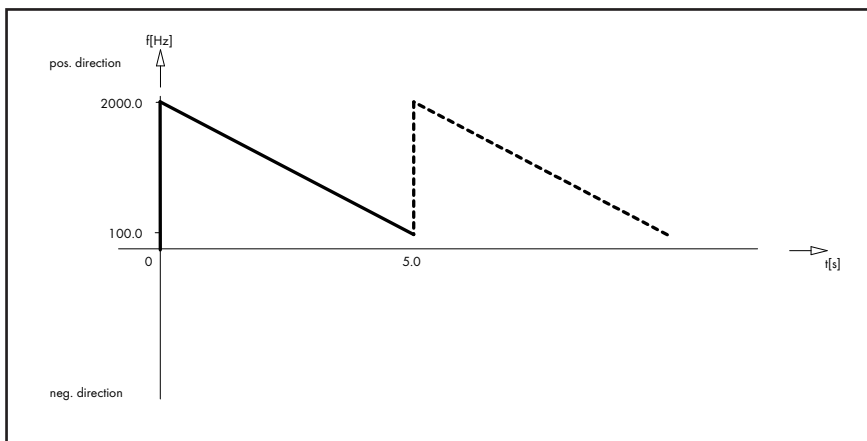

Example 2

Settings:

- Sweep DOWN (FRQ_2 ==> FRQ_1)
- FRQ_1 +000100.0Hz
- FRQ_2 +002000.0Hz
- Start on zero off
- SweepTime 005.0s
- No. of loops 0002

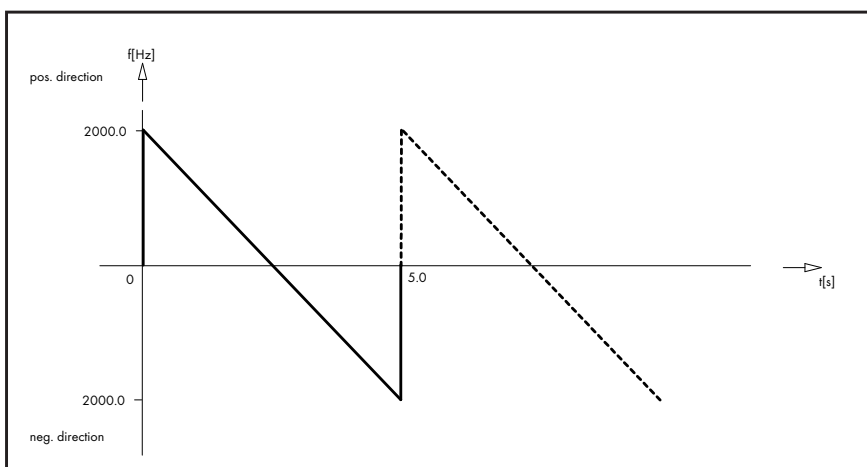

Example 3

Settings:

- Sweep UP (FRQ_1 ==> FRQ_2)
- FRQ_1 +002000.0Hz
- FRQ_2 -002000.0Hz
- Start on zero off
- SweepTime 005.0s
- No. of loops 0002

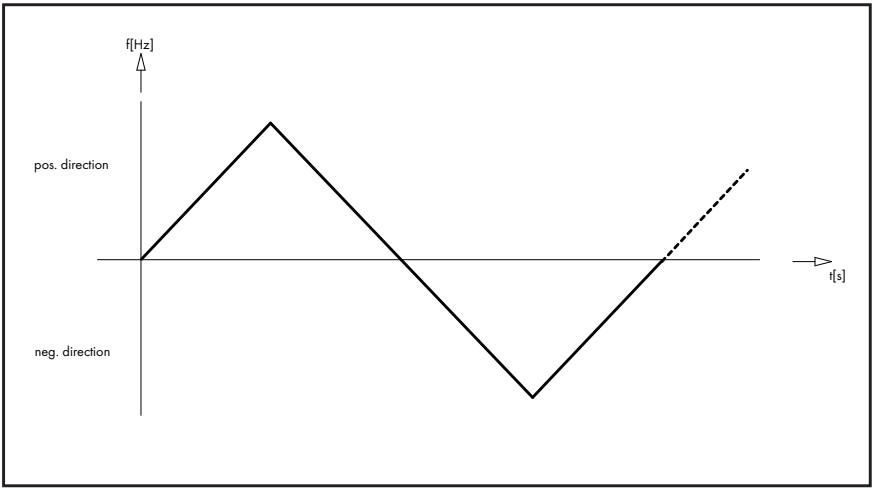

Example 4

- Settings:
- Sweep UP/DOWN
(FRQ_1 ==> FRQ_2 ==> FRQ_1)
 - FRQ_1 +02000.0Hz
 - FRQ_2 -02000.0Hz
 - Start on zero on
 - SweepTime 005.0s
 - No. of loops 0002

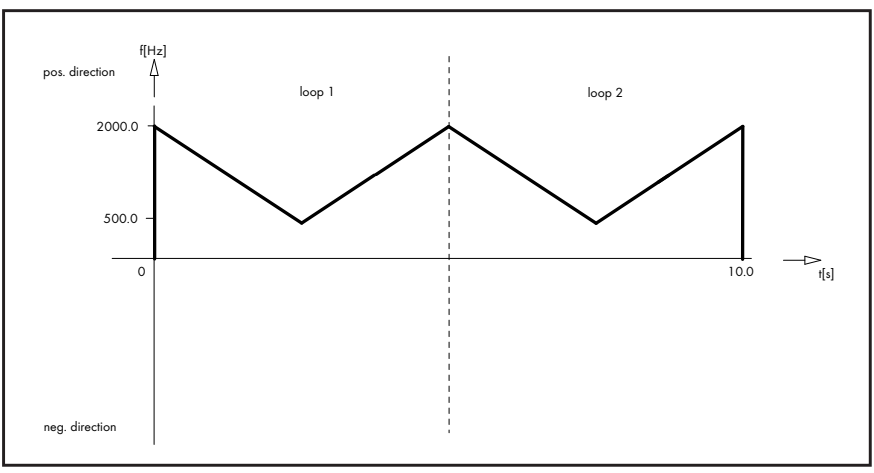

Example 5

- Settings:
- Sweep DOWN/UP
(FRQ_2 ==> FRQ_1 ==> FRQ_2)
 - FRQ_1 +0500.0Hz
 - FRQ_2 +02000.0Hz
 - Start on zero off
 - SweepTime 005.0s
 - No. of loops 0002



6.3. Operating the „sweep“ mode of operation

Adjusting the sweep parameters:

General operation of the "sweep" mode of operation









<ul style="list-style-type: none"> Change between each of the menu items Entering the selected menu item (only possible if sweep is disabled!) Enable / Disable the sweep output (Activation only possible outside of the start / stop menu items possible!) 	<pre>Mode SWEEP [Start] >Sweep UP/DOWN >FRQ_1 -000250.0Hz >FRQ_2 +000250.0Hz ----- >Start on zero off >Sweep Time 000.5s >No. of loops 1000 >change Mode MANUAL</pre>	<ul style="list-style-type: none"> Mode of operation display; Status of the sweep output Sweep functions selection menu item Frequency entry FRQ_1 menu item Frequency entry FRQ_2 menu item Start on zero menu item Time entry menu item Number of loops menu item Mode of operation selection menu item
------------------------------------------------------------------------------------------------------------------------------------------------------------------------------------------------------------------------------------------------------------------------------------------------------------	----------------------------------------------------------------------------------------------------------------------------------------------------------------------------------------------	-----------------------------------------------------------------------------------------------------------------------------------------------------------------------------------------------------------------------------------------------------------------------------------------------------------------------------------------------------------------------------------------

Operation of the "sweep mode" menu item

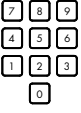

<pre> Mode SWEEP [Start] xSweep <u>U</u>P/DOWN >FRQ_1 -000250.0 Hz >FRQ_2 +000250.0 Hz ----- >Start on zero off >SweepTime 000.5s >No. of loops 1000 >change Mode MANUAL </pre>	<p>Sweep functions selection menu item</p> <p>  Selecting the sweep mode (UP; DOWN; UP/DOWN; DOWN/UP)</p> <p> Confirmation of the selected sweep mode Return to the menu item selection</p>
--------------------------------------------------------------------------------------------------------------------------------------------------------------------------------------------------------	----------------------------------------------------------------------------------------------------------------------------------------------------------------------------------------------------------------------------------------------------------------------------------------------------------------------------------------------------------------------------------------------------------------------------------------------------

UP : FRQ_1 >> FRQ_2 UP/DOWN : FRQ_1 >> FRQ_2 >> FRQ_1
DOWN : FRQ_2 >> FRQ_1 DOWN/UP : FRQ_2 >> FRQ_1 >> FRQ_2

Operation of the "frequency entry FRQ_1; FRQ_2" menu item

<pre> Mode SWEEP [Start] >Sweep UP/DOWN xFRQ_1 -000<u>2</u>50.0 Hz xFRQ_2 +000<u>2</u>50.0 Hz ----- >Start on zero off >SweepTime 000.5s >No. of loops 1000 >change Mode MANUAL </pre>	<p>Frequency entry menu item FRQ_1</p> <p>Frequency entry menu item FRQ_2</p> <p>  Changing the cursor position</p> <p> or  Changing the direction of rotation in the entry direction</p> <p> Increase the selected number (+1)</p> <p> Decrease the selected number (-1)</p> <p> Direct entering of the numbers</p> <p> Confirmation of the entered frequency value Return to the menu item selection</p>
------------------------------------------------------------------------------------------------------------------------------------------------------------------------------------------------------------	----------------------------------------------------------------------------------------------------------------------------------------------------------------------------------------------------------------------------------------------------------------------------------------------------------------------------------------------------------------------------------------------------------------------------------------------------------------------------------------------------------------------------------------------------------------------------------------------------------------------------------------------------------------------------------------------------------------------------------------------------------------------------------------------------------------------------------------------------------------------------------------------------------------------------------------------------------------------------------------------------------------------------------------------------------------------------------------------------------------

Operation of the "start on zero" menu item

<pre> Mode SWEEP [Start] >Sweep UP/DOWN >FRQ_1 -000250.0 Hz >FRQ_2 +000250.0 Hz ----- xStart on zero <u>o</u>ff >SweepTime 000.5s >No. of loops 1000 >change Mode MANUAL </pre>	<p>Start on zero menu item</p> <p>  Selection (on; off)</p> <p> Confirmation of the selection Return to the menu item selection</p>
--------------------------------------------------------------------------------------------------------------------------------------------------------------------------------------------------------	--------------------------------------------------------------------------------------------------------------------------------------------------------------------------------------------------------------------------------------------------------------------------------------------------------------------------------------------------------------------------------------------------

Operation of the "sweep time" menu item

```

Mode SWEEP [Start ]
>Sweep UP/DOWN
>FRQ_1 -000250.0 Hz
>FRQ_2 +000250.0 Hz
-----
>Start on zero off
xSweep Time 010.5s
>No. of loops 1000
>change Mode MANUAL
  
```

Sweep time menu item



Changing the cursor position



Increase the selected number (+1)



Decrease the selected number (-1)



Direct entering of the numbers



Confirmation of the entered frequency value
Return to the menu item selection

Operation of the "no. of loops" menu item

```

Mode SWEEP [Start ]
>Sweep UP/DOWN
>FRQ_1 -000250.0 Hz
>FRQ_2 +000250.0 Hz
-----
>Start on zero off
>Sweep Time 010.5s
xNo. of loops 0100
>change Mode MANUAL
  
```

Number of loops menu item



Changing the cursor position



Increase the selected number (+1)



Decrease the selected number (-1)



Direct entering of the numbers



Confirmation of the entered frequency value
Return to the menu item selection

Operation of the "mode of operation selection" menu item

```

Mode SWEEP [Start ]
>Sweep UP/DOWN
>FRQ_1 -000250.0 Hz
>FRQ_2 +000250.0 Hz
-----
>Start on zero off
>Sweep Time 010.5s
>No. of loops 0100
xchange Mode MANUAL
  
```

Mode of operation selection menu item







Selection of the mode of operation



Confirmation of the selected mode of operation
Entering the selected mode of operation menu
or return to the menu item selection

7. RESETTING TO THE WORKS SETTING

The testbox can be reset by pressing the keys     simultaneously. This key combination initiates the reset process. The power failure-safe memory is hereby reloaded with "default" values before being reset.

After the reset, the "pulse-generator TB2" is in the "manual" mode of operation.

8. "PULSE - GENERATOR TB2" TESTBOX CONNECTIONS

The "pulse-generator TB2" testbox has a M12 plug and a BNC-socket as standard.

The device is provided with power and outputs the incremental pulse signals via the M12 plug. A connection diagram is shown in Fig. 4.

The "TRIGOUT" trigger outlet for the sweep operation is at the BNC-socket.

Special versions are equipped with an additional M12 plug on the device.

This is situated between the standard M12 plug and the BNC-socket (see Fig. 3).

At this plug, the digital signals can be differentially output at this plug with the supply voltage (HTL level: 10-28 V) or in a RS422 format (level 2-3 V, $f_{max} = 150$ kHz) as requested. Each signal is hereby transmitted to 2 lines with complementary levels. The logic level is determined at the receiver on the basis of the difference between the two lines A, B and /A, /B. This makes long transmission links possible in addition to increasing the interference immunity.

The connection cable should only be a well-screened cable with a wire cross-section of $\geq 4 \times 0.25$ mm². Please note that the round M12 plug has a metallic housing, a connection for the shielding and that the potential of the grounding conductor PE or the ground is connected to the cable screen.

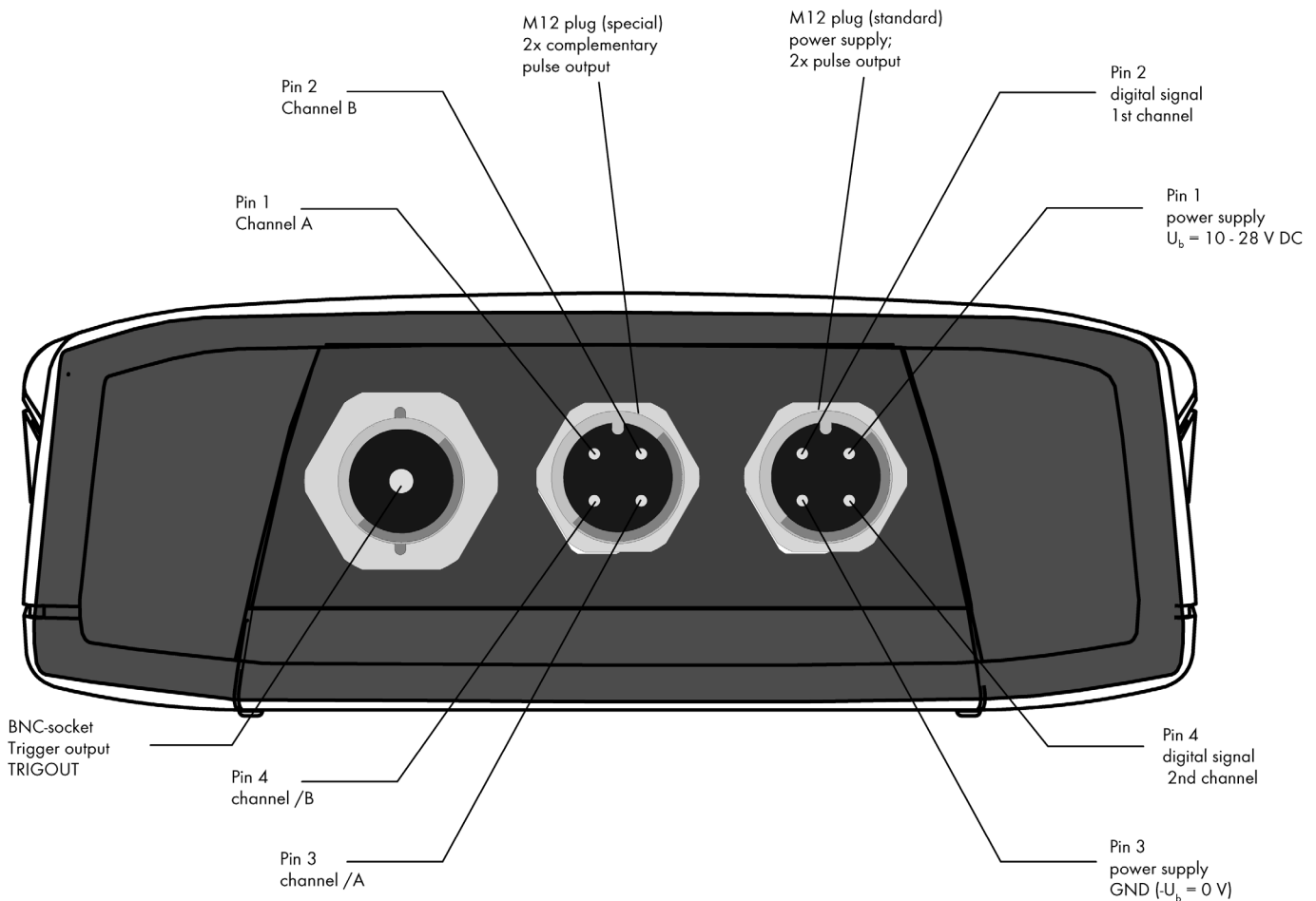

Fig. 3: The "pulse-generator TB2" testbox connections

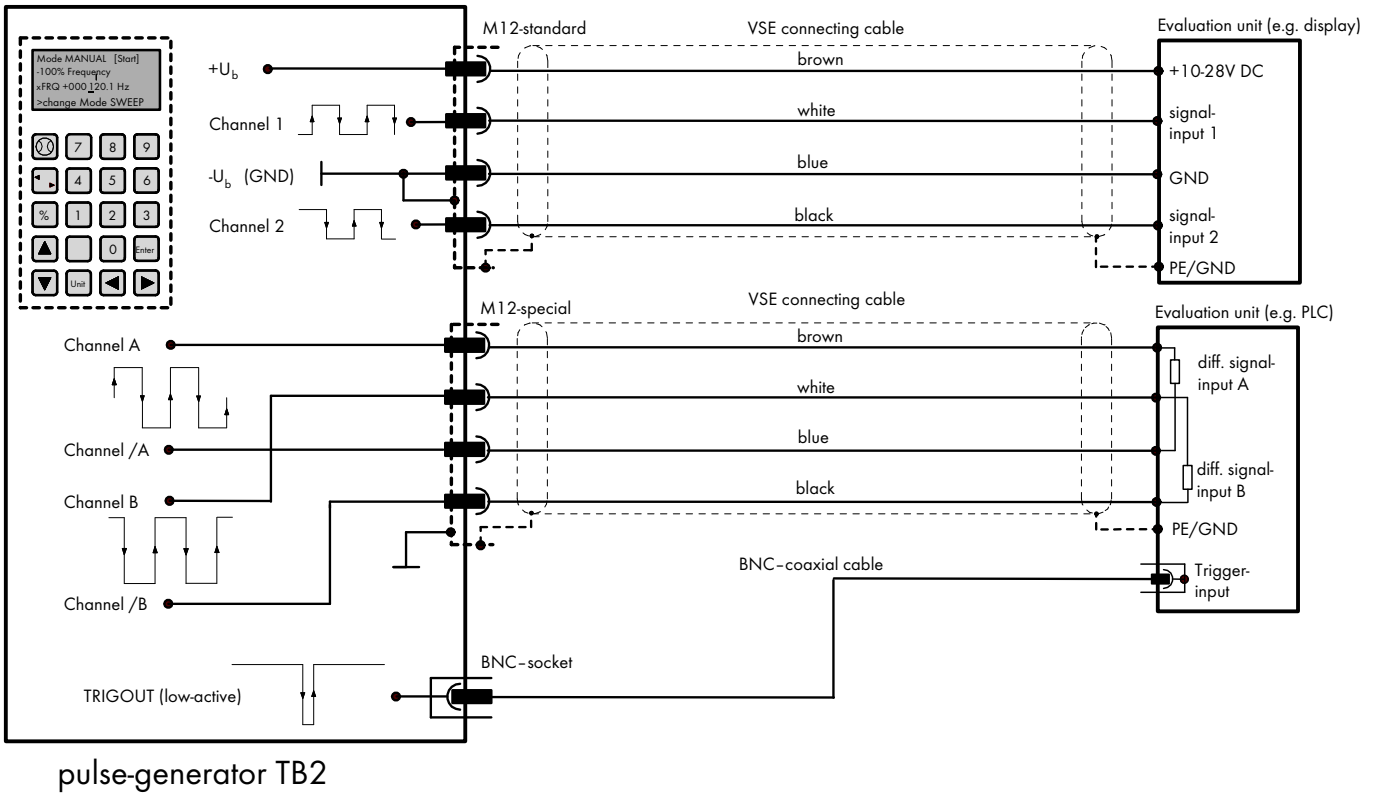

Fig. 4: Connecting diagram for the power supply and the signal outputs

Power supply

Supply voltage	$U = 10 \dots 28 \text{ V DC}$; voltage reversal-safe
Current consumption	$I_0 = 42 \text{ mA}$ (at 24 V DC); unloaded

Signal outputs (standard)

Signal voltage output (channel 1; channel 2)	$U_{SS} = 9 \dots 27 \text{ V DC}$
Signal output current	$I_{OUT} = 300 \text{ mA max}$ at 24 V DC (channel 1; channel 2)
Output preamps	Push-Pull preamps; current limited; short-circuit proof; internal cable adaptation; low saturation voltage; temperature protection circuit with hysteresis; high-impedance outlets in case of failures

Additional signal outputs (special):

Signal output	Channel A, /A (with inversion), Channel B, /B (with inversion)
Signal output level	HTL level 10 - 30 V or RS422 level
Signal voltage output	$U_{SS} = 8 \dots 27 \text{ V DC}$ differential (with HTL) $U_{SS} = 0,4 \dots 3,2 \text{ V DC}$ differential (with RS422)
Signal output current	$I_{OUT} = 200 \text{ mA}$ (with HTL), $I_{OUT} = 20 \text{ mA}$ (with RS422)
Output preamps	Push-Pull preamps; current limited; short-circuit proof; internal cable adaptation (with HTL) or RS422-driver AM26C31 ($f_{max} = 150 \text{ kHz}$)

Housing

Dimensions	L x W x H 209,3 x 98 x 34,8 mm
Material	ABS (acrylonitrile-butadiene-styrene)
Color	graphite gray
System of protection	IP64

VSE.flow®

VSE Volumentchnik GmbH
Hönnestraße 49
58809 Neuenrade / Germany

VSE Volumentchnik GmbH
Postfach/P.O.Box 1229
58804 Neuenrade / Germany

Phone +49 (0) 23 94 / 6 16-30

Fax +49 (0) 23 94 / 6 16-33

info@vse-flow.com

www.vse-flow.com

e.holding
FLUID TECHNOLOGY GROUP
www.e-holding.de